

J.L.Fisher

Motion Picture &
Television Equipment

MODEL 10 CAMERA DOLLY

RECOGNIZED AS THE INDUSTRY STANDARD HYDRAULIC LIFT DOLLY

Our most popular hydraulic lift beam camera dolly. It is smooth, quiet and easy to use, with a reputation for being well-made and low maintenance. Manufactured from the highest quality materials and components to meet the demanding needs of the entertainment industry, this stable, reliable Dolly offers operators a wide variety of accessories. The versatile Model 10 Dolly also incorporates many features and options suggested by our customers.

500 LB (227kg) LIFT BEAM CAPACITY

Over the years, J.L. Fisher has pioneered many innovative features that have become standard on the Model 10, and copied by others. Mechanically compensated Round Steering Mode was introduced on the Model 10 over twenty-five years ago.



Engineered and handcrafted to be the most reliable camera dolly available, the Model 10 has the lowest maintenance of any hydraulic lift beam camera dolly. Grips and rental houses appreciate its outstanding dependability and ease of use... just ask them.

Courtesy of Red Star
redstarpictures.com

STEERING MODES

REAR (CONVENTIONAL):
Front wheels are locked, rear wheels can rotate 360°.

CRAB: Front and rear wheels can rotate in unison 360°.

ROUND: Front and rear wheels rotate independently with mechanical compensation to allow variable radius turns, even down to 0 radius.

WIDE: Front and rear wheels can rotate 180° in any steering mode, providing a wider wheel track for greater stability.

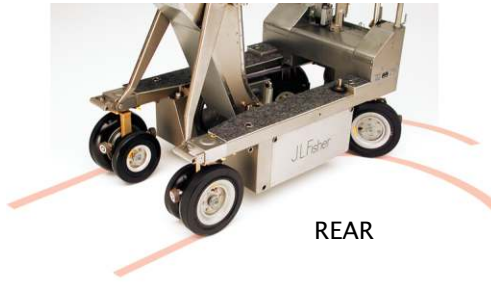

REAR

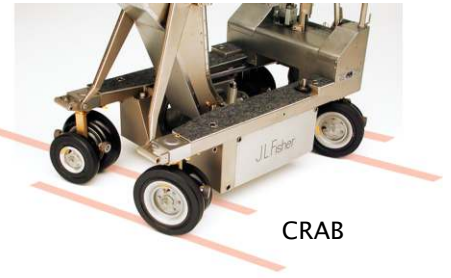

CRAB

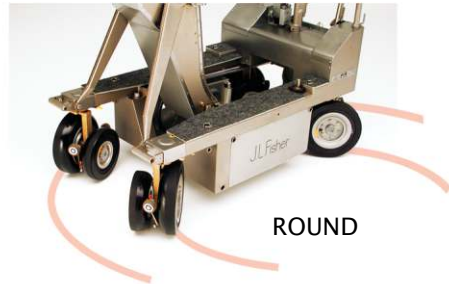

ROUND

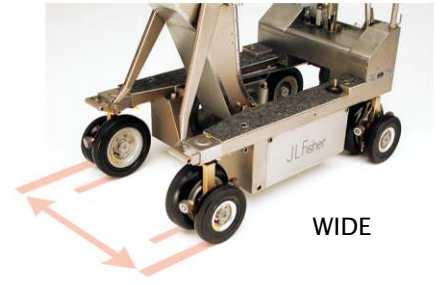

WIDE

ACCEPTS 90 TO 240 VOLTS AC OR DC TO CHARGE THE HYDRAULIC LIFT SYSTEM IN AS LITTLE AS THREE MINUTES

REMOVABLE PUSH POSTS

UTILITY HOOKS

SINGLE LEVER POSITIVE LOCKING BRAKE SYSTEM

SELF-CONTAINED TRACK GUIDE SYSTEM

4 WAY LEVEL HEAD

CABLE CLIPS ON BEAM

8 SEAT MOUNT LOCATIONS

SLIDING, CLOTH COVERED CUSHIONED SEATS WITH ADJUSTABLE HEIGHT

CARPETED STANDING AREAS

BATTERY BOX

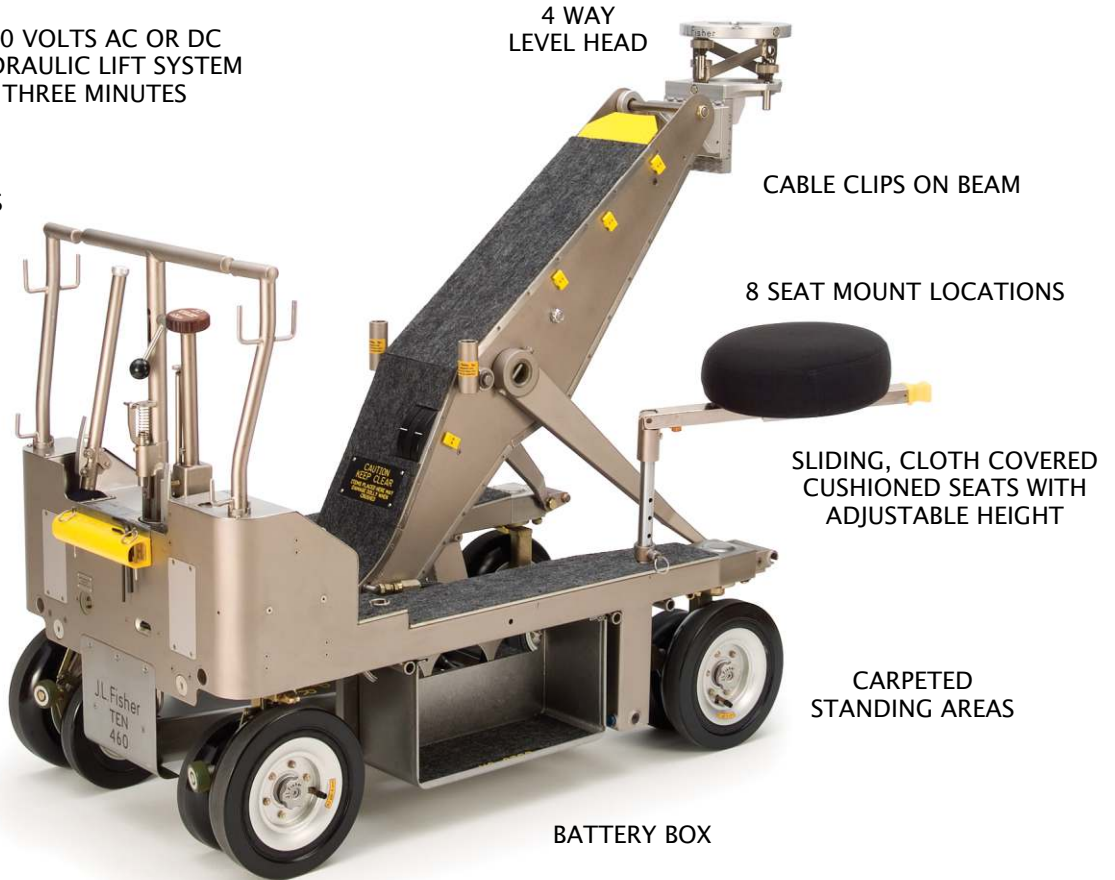

PUSH POSTS DOUBLE AS REAR CARRY HANDLES



POSITIVE LOCKING BRAKES



BUILT-IN TRACK GUIDES (Square Track Only)



MITCHELL MOUNT LEVELING HEAD WITH 4 WAY ADJUSTMENT AND 360° ADJUSTABLE DIAMOND PLATE



NEW CUE BOX WITH VARIABLE LIFT RATE MEMORY STOPS AND ADJUSTABLE DRAG KNOB

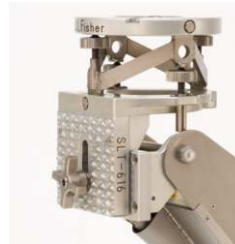

LEVELING HEAD CAN BE REVERSED



SELF CENTERING HYDRAULIC LIFT BEAM CONTROL KNOB WITH SAFETY LOCK

SEVEN LIFTS PER SYSTEM CHARGE

SELF-BLEEDING HYDRAULIC SYSTEM

500 lb. (227kg) LIFT BEAM CAPACITY

LIFT BEAM POSITION (CUE) INDICATOR

SELF-DAMPENING LIFT BEAM SYSTEM



OPTIONAL UP/DOWN LEVER WITH SAFETY LOCK

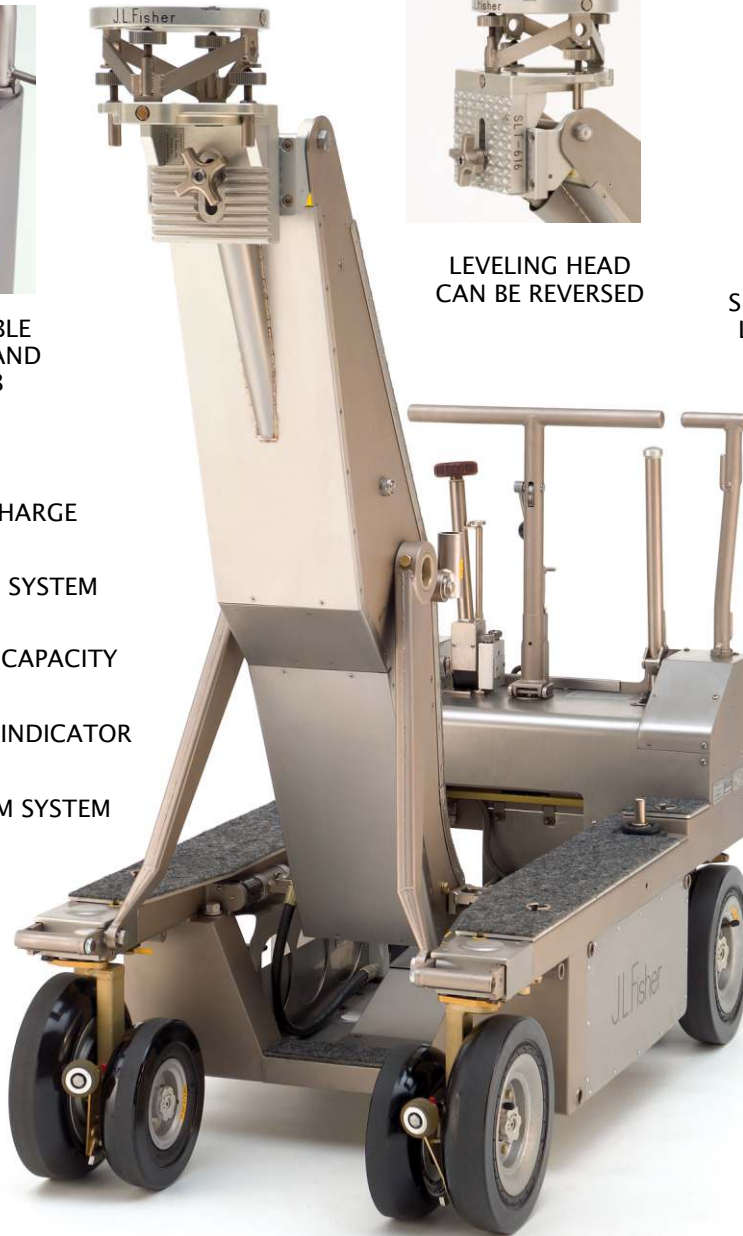

PNEUMATIC TIRES



HYDRAULIC HAND PUMP FOR LOCATION WORK

The Model 10 Dolly has a maximum load capacity of 1200 lbs. (544 kg)



LIFT BEAM (CUE) INDICATOR



Power Requirements:
90 TO 240 VOLTS AC OR DC



NEW Fully articulated skateboard wheels
(Patents Pending)

STANDARD RENTAL PACKAGE

The Standard Rental Package includes these items:

- 1 SLT 4-way Level Head
- 1 HS Hand Screw (for SLT)
- 1 ST Small Seat
- 1 S Large Seat
- 2 PP Push Posts
- 2 LT Low Side Boards
- 2 F Front Boards
- 1 HTL High Side Board (Left)
- 1 HTR High Side Board (Right)
- 2 CH Carry Handles
- 1 PC Power Cord
- 2 FPIN Front Pins
- 1 BPR Knee Bumper
- 2 AWR Allen Wrenches
- 4 TLW Pneumatic Tires (large)
- 4 TSW Pneumatic Tires (small)
- 1 PBY Battery Box



TLW/TSW

OPTIONAL ACCESSORIES

*Asterisk indicates items are included in the FULL RENTAL PACKAGE

Dolly Boards & Platforms

- BST* Beam Step Standing Platform
- DTL* Diving Board, Left
- DTR* Diving Board, Right
- SFB Short Front Board
- SNFB Short Narrow Front Board
- FBB* Front Board Bridge
- FP Front Porch
- LFB Low Front Board



FP

SFB

SNFB

LFB

Popular Accessories

- AC* Accessory Carts (pair)
- FPCH Four Person Carry Handles
- PB Push Bar
- UDJ Dolly Jack (uses Push Post for handle)
- UTT Utility Tray (Ten Dolly)



PB



FPCH

UDJ



UTT



MORE OPTIONAL ACCESSORIES

*Asterisk indicates items are included in the FULL RENTAL PACKAGE

Risers

- R3 Camera Riser, 3" (7.6cm)
- R6* Camera Riser, 6" (15.2cm)
- R12* Camera Riser, 12" (30.5cm)
- R6BA Camera Riser w/ 75mm Ball Adapter, 6" (15.2cm)
- R6BB Camera Riser w/ 100mm Ball Adapter, 6" (15.2cm)
- R6BC Camera Riser w/ 150mm Ball Adapter, 6" (15.2cm)
- R12BA Camera Riser w/ 75mm Ball Adapter, 12" (30.5cm)
- R12BB Camera Riser w/ 100mm Ball Adapter, 12" (30.5cm)
- R12BC Camera Riser w/ 150mm Ball Adapter, 12" (30.5cm)
- RJ6 Heavy Duty Camera Riser, 6" (15.2cm)
- RJ12 Heavy Duty Camera Riser, 12" (30.5cm)
- RJ18 Heavy Duty Camera Riser, 18" (45.7cm)
- RJ24 Heavy Duty Camera Riser, 24" (61cm)
- RJ36 Heavy Duty Camera Riser, 36" (91.4cm)



Angle Plate

- AP* 90-Degree Camera Angle Plate



Offsets

- U* Camera Offset, 10" (25.4cm)
- TH* Camera Offset, 24" (61cm)
- RO* Rotating Offset
- ROB Rotating Offset w/ Ball Adapter, 150mm
- ROL Rotating Offset, Low
- ROHL Rotating Offset, High/Low
- ROX Rotating Offset, Long
- ROXL Rotating Offset, Long, Low
- ROP Rotating Offset, Pivot



Adapters

- 75A 75mm Ball Adapter
- 100A 100mm Ball Adapter
- 150A 150mm Ball Adapter
- UA Universal Adapter
- HBA Half-Ball Adapter
- ESLT Euro Boss Adapter
- MEA Mitchell Euro Adapter



Low Level Head

- LHT* 4-way Low Level Head
- LHA Low Head Adapter
- WAT Waffle Adapter



Seat & Seat Accessories

- RS Rotating Seat
- SOH* Seat Offset High
- SOL Seat Offset Low (Includes Seat)
- SOS* Seat Offset Straight
- SSOS Seat Offset Short
- SR6* Seat Riser Adjustable
- BR/MLA Seat w/Backrest & Adapter (for use w/SLT only)
- SBKR Seat w/Backrest



MORE OPTIONAL ACCESSORIES

Jib Arms

JIB23 Model 23 Sectional Jib Arm, 21' (6.4m) Reach

SEVEN SIZES ALL IN ONE BOX



Utility Cart rear view showing section storage

Utility Cart & Weight Carts

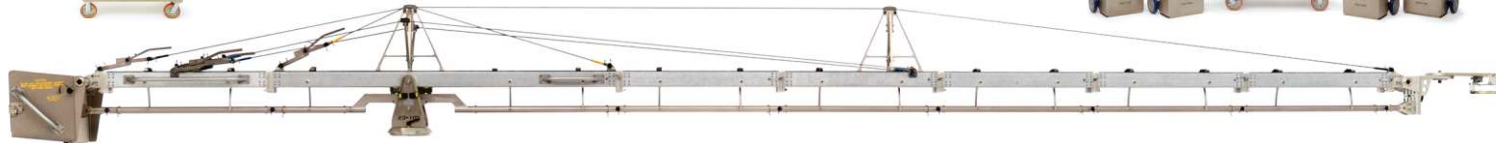

Please refer to the Jib Arm Brochure or our web site, www.jfisher.com, for full specifications and options available

JIB20 Model 20 Jib Arm, 51.5" (131cm) Reach

JIB21 Model 21 Jib Arm, 68.5" (174cm) Reach

JIB22 Model 22 Jib Arm, 99.5" (253cm) Reach



Crossarms

CRA1 Crossarm, 11.5" (29cm) to 19" (48cm) Reach

CRA2 Crossarm, 15" (38cm) to 24" (61cm) Reach

CRA3 Crossarm, 18" (46cm) to 29" (74cm) Reach

CRA4 Crossarm, 23" (58cm) to 36" (91cm) Reach

CRA6 Crossarm, 31" (79cm) to 53" (135cm) Reach

CRA8 Crossarm, 40" (102cm) to 68" (173cm) Reach

CRA12 Crossarm, 54" (137cm) to 100" (254cm) Reach



Fluid Heads

WS2 Weaver/Steadman Fluid Head, 2 Axis

WS3 Weaver/Steadman Fluid Head, 3 Axis

V Vector 700 Fluid Head, 2 Axis



WS2



WS3



V

Other Accessories

BAZ Bazooka (Pneumatic or Sectional)

CM Center Mount with RJ12 Riser

CB Cue Board

HH High Hat

LA Lamp Adapter

MLA Mitchell Lamp Adapter, Junior 1 1/8 in.

SCOA Scooter Board with Articulating Wheels

- 4-sets Articulating Wheels
- Mitchell Mount
- 4-Tie downs
- 4-Speed rail receivers
- 4-Carrying handles
- 44-3/8" pre drilled holes for high hats and other accessories
- 3-Tripod foot locators
- 34 1/2" W x 53" L



BAZ

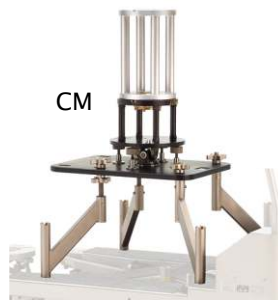

CM



CB



HH



LA



MLA

SCOA

SBWS / DSBC

SCOA and SBWS
All 32 wheels maintain contact on both straight and curved round track.

Wheels & Ice Skates

SHW Shaved Wheel

SK Ice Skates

TTW Round Track Wheels

SCWT Soft Compound Wheels

SWT Soft Wheels

SBWS Skateboard Wheels

DSBC Dexter Skateboard Wheels



SHW



SK



TTW



SCWT



SWT

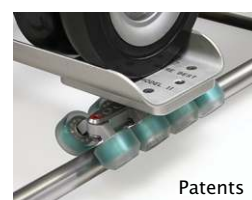

SBWS / DSBC

Patents Pending

Track & Track Accessories

Straight Track sections fold from 24.5" wide to 5" wide for easy transport and storage

Straight Track

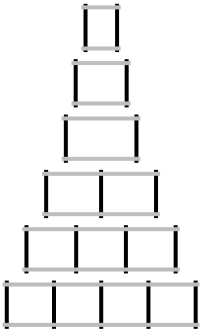

| | Length | Length (folded) | Weight |
|------|-----------|-----------------|-------------------|
| TR2 | 2' (.61m) | 4.1' (1.3m) | 11.8 lbs (5.4kg) |
| TR3 | 3' (.91m) | 5.1' (1.6m) | 15.0 lbs (6.8kg) |
| TR4 | 4' (1.2m) | 6.1' (1.9m) | 16.2 lbs (7.3kg) |
| TR6 | 6' (1.8m) | 8.1' (2.5m) | 23.8 lbs (10.8kg) |
| TR | 8' (2.4m) | 10.1' (3.0m) | 30.2 lbs (13.7kg) |
| TR10 | 10' (3m) | 12.1' (3.7m) | 38.0 lbs (17.2kg) |

○ Round Tube Track 1.5" (3.8cm) Diameter

All J.L. Fisher track is on 24.5" (62.23cm) center line between rails.

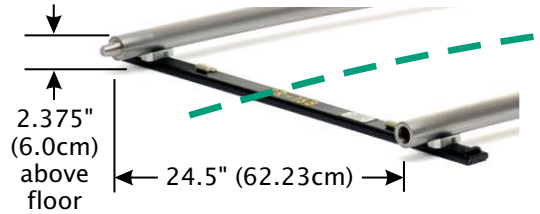

Curved Track Diameters are Measured from Centerline Between Rails

Square tube dolly track, not shown here, is available in similar sizes and diameters as the round tube track. Please call J.L. Fisher for sizes and availability.



TS Track Support



Curved Track

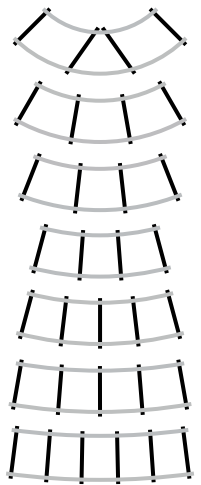

| | Diameter Full Circle | Angle Section | Sections For Full Circle | Length* Section | Width* Section | Weight Section |
|------|----------------------|---------------|--------------------------|-----------------|----------------|-------------------|
| CR10 | 10' (3m) | 90° | 4 | 8.7 ft (2.7m) | 3.2 ft (.96m) | 31.2 lbs (14.2kg) |
| CR15 | 15' (4.6m) | 60° | 6 | 8.5 ft (2.6m) | 3.1 ft (.94m) | 30.5 lbs (13.8kg) |
| CR | 20' (6.1m) | 45° | 8 | 7.8 ft (2.4m) | 3.0 ft (.91m) | 29.0 lbs (13.2kg) |
| CR25 | 25' (7.6m) | 30° | 12 | 7.1 ft (2.2m) | 2.8 ft (.85m) | 27.8 lbs (12.6kg) |
| CR30 | 30' (9.1m) | 30° | 12 | 8.4 ft (2.6m) | 2.9 ft (.88m) | 33.8 lbs (15.3kg) |
| CR50 | 50' (15.2m) | 20° | 18 | 9.2 ft (2.8m) | 2.8 ft (.85m) | 34.5 lbs (15.6kg) |
| CR70 | 70' (21.3m) | 15° | 24 | 9.5 ft (2.9m) | 2.8 ft (.85m) | 38.8 lbs (17.6kg) |

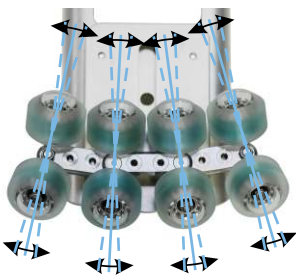

EACH SET OF 2 WHEELS (TRUCK) CAN SWIVEL INDEPENDENTLY



Model 10 Dolly shown with High Side Boards and Track Wheels on Round Curved Track

* Example

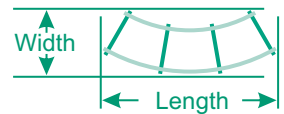

RMPR Track Ramp For Round Track
WED Track Wedges
TB Track Buckle

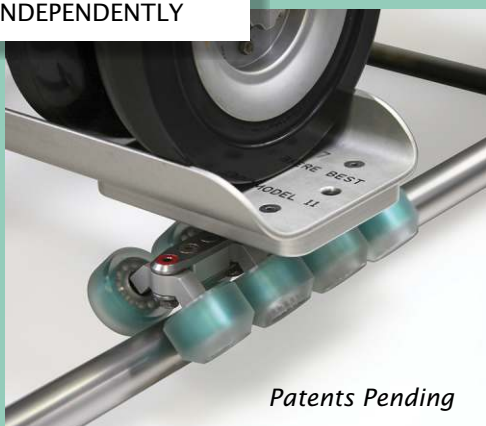

Patents Pending

FULLY ARTICULATED SKATEBOARD WHEELS (SBWS)



TRACK WHEELS (TTW) ON ROUND STRAIGHT TRACK (TR)



BUILT-IN TRACK GUIDES ON SQUARE TRACK (STR)

| | |
|--|--|
| Maximum Lift Beam Elevation | 63 in. (160 cm) |
| Minimum Elevation (standard head)..... | 13.75 in. (35 cm) |
| Minimum Elevation (low level head)..... | 3.325 in. (9 cm) |
| Vertical Beam Travel | 47 in. (119 cm) |
| Lift Beam Capacity | 500 pounds (227 kg) |
| Lifts per System Charge | 7 |
| Length | 55.25 in. (140 cm) |
| Width (wheels in) | 26.625 in. (68 cm) |
| Width (wheels out) | 32 in. (81 cm) |
| Height (operating)..... | 38.5 in. (98 cm) |
| Height (folded)..... | 25 in. (64 cm) |
| Height (center mount, before riser) | 38.75 in. (98 cm) |
| Minimum Turn Radius (round steering) | 22 in. (56 cm) |
| Minimum Turn Radius (conventional steering)..... | 44 in. (112 cm) |
| Maximum Dolly Load Capacity..... | 1200 pounds (544 kg) |
| Battery Box (PBY) inside dimensions..... | 16 in. (40.6 cm) W x 7 in. (17.8 cm) H x 6 in. (15.2 cm) D |
| Carrying Weight | 435 pounds (197 kg) |
| Crated Size..... | 59 in. (150 cm) L x 31 in. (79 cm) W x 34 in. (86 cm) H |
| Crated Weight | 928 pounds (421 kg) (standard package) |

DIMENSIONS

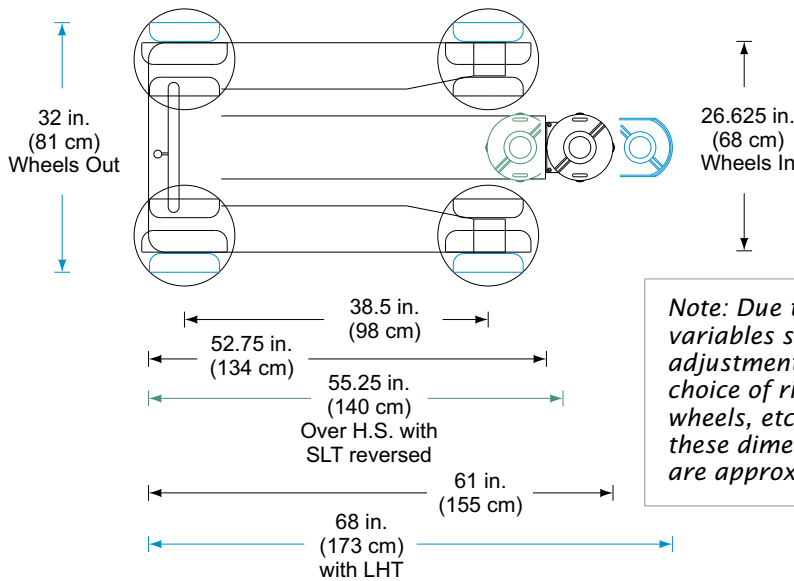

Note: Due to variables such as adjustments and choice of risers, wheels, etc., these dimensions are approximate.

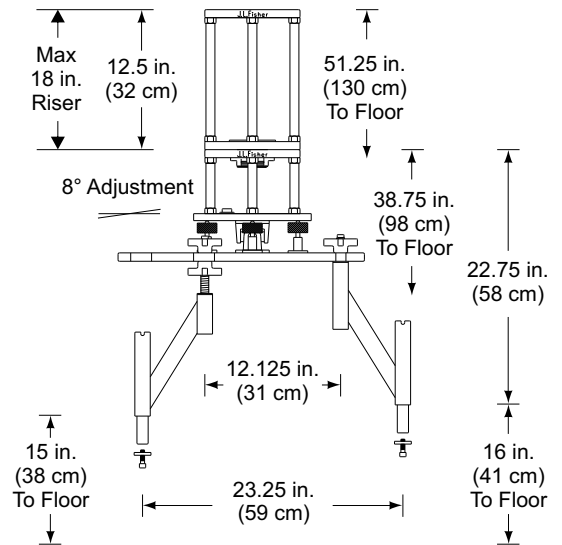

CENTER MOUNT (CM)

The Center Mount (CM), supports jib arms, lightweight camera booms and counterbalanced camera cranes. The Center Mount has thumbscrews for four-way leveling adjustment and a leveling indicator. Easily installed, the Center Mount has a standard Mitchell mount and comes with a heavy duty 12-inch Riser (RJ12).

The maximum gross load capacity is 1200 pounds (544 kg). Center Mount is not for supporting personnel or personnel carrying cranes.

MODEL 10 DOLLY

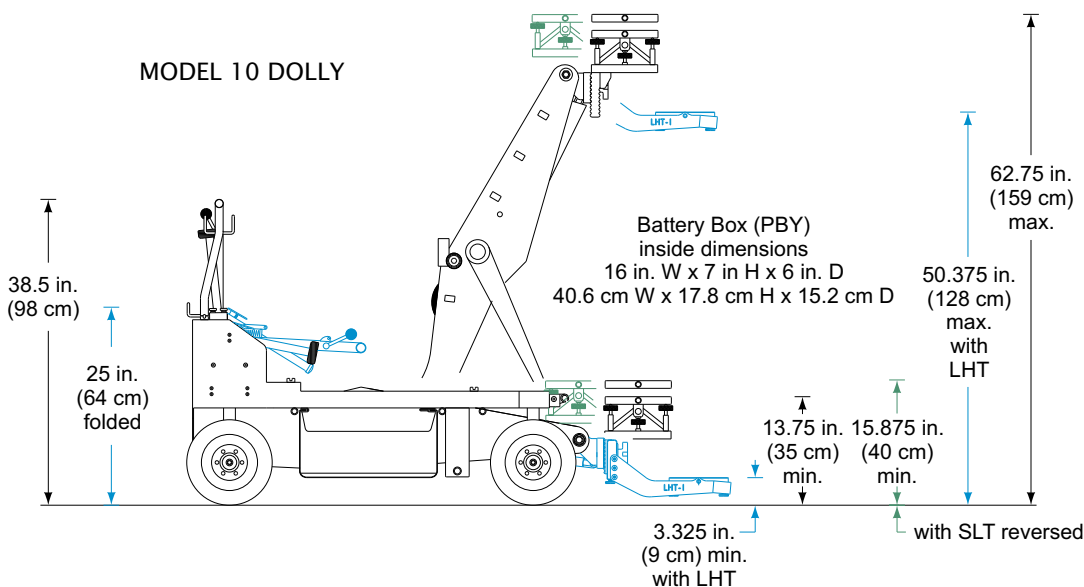

FOLDING CONTROLS

J.L. FISHER PRODUCTS ARE PROUDLY MADE IN BURBANK, CALIFORNIA U.S.A.

J.L. Fisher, Inc. Motion Picture & Television Equipment
 1000 W. Isabel Street, Burbank, CA 91506 U.S.A.
 Tel: (818) 846-8366 / Fax: (818) 846-8699
 Web: www.jlfisher.com e-mail: info@jlfisher.com

J.L. Fisher, GmbH Emil-Hoffmann-Str. 55-59 50996 Köln, Germany
 Tel: +49 2236 3922 0 Fax: +49 2236 3922 12
 Web: www.jlfisher.de e-mail: info@jlfisher.de